



2017 Industrial Blade Assembly



Table Top Blades

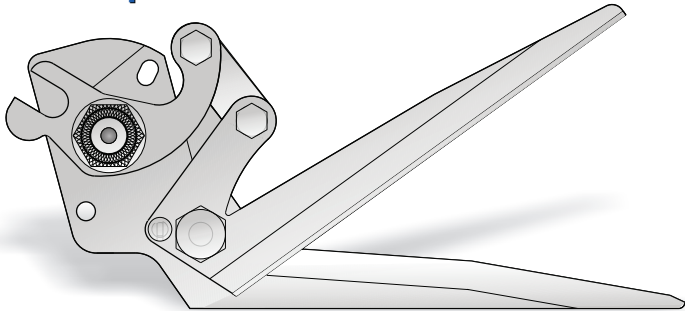
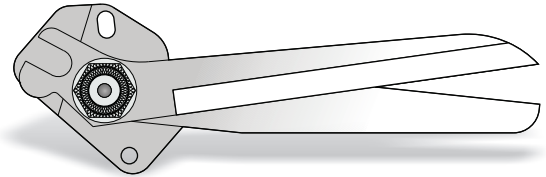
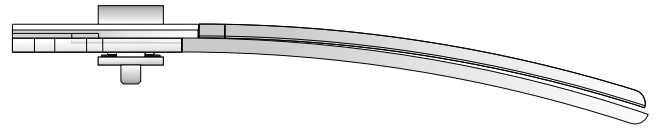

Table Top

- 4 1/4" Standard Blade - 35° Cut Angle #103361
- 4 1/4" HD-Blade - 25° Cut Angle #108849
- 5" Standard Blade #108505
- 5" Standard Blade (Micro-Serrated) #108700
- 5" HD-Blade (Micro-Serrated - Kevlar®) #108720
- 5" HD-Blade - 35° Cut Angle (Rubber) #104487

HD = Heavy Duty

Curved Blades



4 1/4" Curved Blade #108054

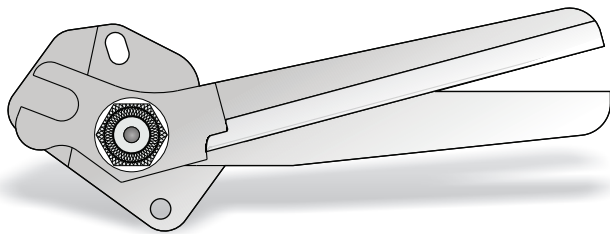

3 7/8" Kevlar® Straight Blade # 108702
Micro-Serrations

Low Profile Straight Blade

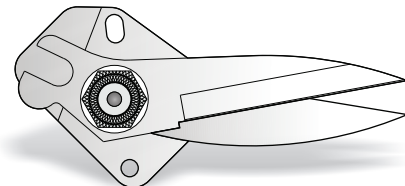

2 1/2" Low Profile Blade #108496

Typical Application:
General Industry

Side Cutters

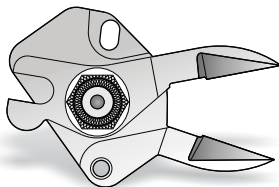

Side Cutters #108526

Typical Applications:
Industrial - Wire cutting

Low Profile Straight Blade

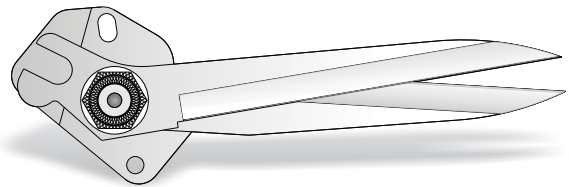

4 1/4" Low Profile 35° Blade #108475

Typical Applications:

- Rubber
- Plastic tubing

2017 Industrial Blade Assembly

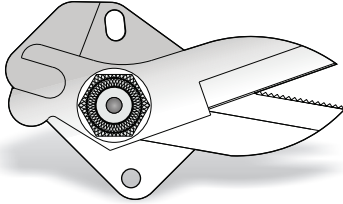

1 3/8" Short Straight Blade #108498
(Serrated)

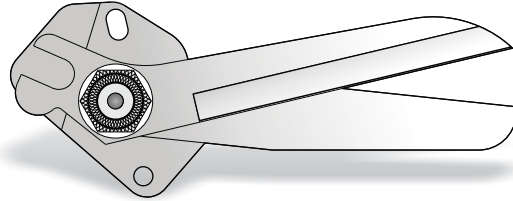

3 1/4" Short Straight Blade #108169

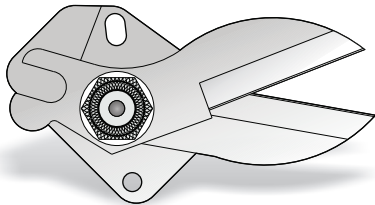

1 11/16" Straight Blade #108499

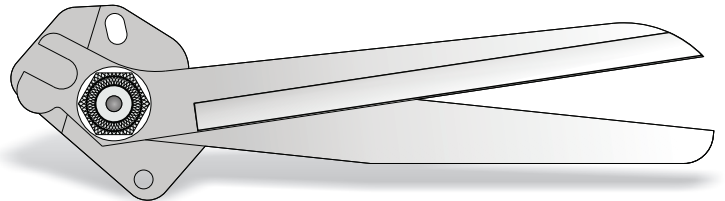

5 1/4" Straight Blade #108361
4 1/4" Straight Blade #108053

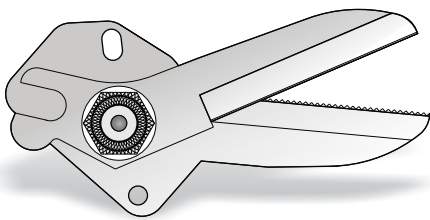

2 1/2" Straight Blade #108539
(Serrated)



www.bettcher.com

Headquarters: 6801 State Route 60 | Birmingham, OH 44889 USA | Offices in Brazil, China and Europe
Tel: 800-321-8763 **Fax:** 440-328-4535 | sales@bettcher.com | U.S. and International Patents
© 2017 Cannot be duplicated without prior written permission from Bettcher Industries, Inc.

AirShirz is a trademark of Bettcher Industries, Inc. US and International patents. ©2017 Bettcher Industries, Inc. ASB-10.11